

**TpC-FS4W123**  
**TpC-PS4W123**  
**TpC-PS4L123**  
**TpC-PS4M123**



## **Tapioca TpC-xS4x12x (Wireless to RS485) Datasheet**

Tapioca monitors and modifies variables in a target system by wirelessly connecting to the target's system bus. Tapioca adapters support:

- Wire connection via RS485.
- Wireless connection via NFC, Bluetooth Smart "Low Energy" (BLE), and Wi-Fi (IEEE 802.11 b/g/n)
- LoRa and LTE-M/NB-IoT LPWAN connections (extension board required).

**3 November 2023**  
**Version 1.3**

## Contents

1	Introduction .....	4
2	Summary .....	5
3	Block diagram .....	6
3.1	Serial modes with RS485 .....	6
4	Features.....	7
4.1	Radio communication channels.....	7
4.1.1	Near Field Communication (NFC) .....	7
4.1.2	Bluetooth Low Energy (BLE) .....	7
4.1.3	Wi-Fi (IEEE 802.11b/g/n).....	7
4.1.4	LoRa .....	7
4.1.5	LTE-M/NBIOT .....	7
4.2	Wired communication channel .....	8
4.2.1	RS485.....	8
4.2.2	Communication cables .....	8
4.3	Electrical characteristics .....	9
4.3.1	Power supply .....	9
4.3.2	Power consumption .....	9
4.4	Radio specifications.....	11
4.4.1	Bluetooth Low Energy (BLE 4.2) and Wi-Fi (IEEE 802.11 b/g/n).....	11
4.4.2	LoRa (LoRaWAN 1.0.3).....	11
4.4.3	LTE-M/NBIOT .....	11
4.5	Security features.....	11
4.6	Embedded user's memory.....	11
4.7	Low power modes.....	12
4.8	Temperature ranges .....	12
4.8.1	Operating temperature.....	12
4.8.2	Storage temperature.....	12
5	Software environment.....	13
5.1	Device configuration .....	13
5.2	Mobile device support.....	13
5.3	Cloud support .....	13
6	Hardware Description .....	14
6.1	Overview .....	14
6.1.1	Standard DIN Rail Case .....	15
6.1.2	Fixed IP67 Case .....	15
6.2	Connectors .....	16
6.2.1	Standard DIN Rail Case .....	16

6.2.2	Fixed IP67 Case .....	17
6.3	Hardware factory reset .....	18
6.4	RS485 termination .....	19
6.5	Configurable RGB LED .....	20
7	Mechanical characteristics .....	21
7.1	Standard DIN Rail Case .....	21
7.2	Fixed IP67 Case .....	22
8	Regulatory compliance .....	23
8.1	CE certification (Europe) .....	23
8.2	RoHS and WEEE.....	23
8.3	FCC (USA).....	23
8.4	IC (CANADA).....	23
9	Ordering information .....	24
10	Appendices .....	25
10.1	EU Declaration of Conformity (DoC) .....	25
10.2	Recycling .....	27
10.3	RS485 M12 connector pinout .....	28
11	History.....	29

# 1 Introduction

## Connect existing electronic systems to mobile apps

The Tapioca line is designed to be added on a standard fieldbus or system bus that is already designed into the target system. These specific variants support physical connection on RS485 and are available either in the standard DIN rail or the IP67 case.

All Tapiocas offer the following range of standard RF channels:

- NFC
- Bluetooth Smart "Low Energy" (BLE)
- Wi-Fi (IEEE 802.11 b/g/n)

Tapioca extensions are available for the IP67 case to add long-range, low power RF channels:

- LoRa
- LTE-M, NB-IOT

NFC and BLE channels allow direct, local connection between the Tapioca and a mobile app that can be automatically generated.

Wi-Fi can be configured for either local connection to mobile apps or connection to networks to send data or alarms to a cloud-based platform using the MQTT protocol.

Long-range, low power RF channels allow the sending of data or alarms to a cloud-based platform using the MQTT or the LoRaWAN protocol.

For connection to cloud platforms, messages and data can easily be formatted using Tapioca's embedded Virtual Machine.

## Hierarchy between Tapioca and target electronic equipment

There are two ways for connecting Tapioca to a system bus (ex. Modbus RTU):

1. Tapioca acts as a server (slave), and the other devices (master) on the bus can access its variables.
2. Or, Tapioca acts as a client (master) and accesses specific addresses or address ranges in the memory space of the servers (slaves) that are available on the bus.

Depending on this choice, the variables shared between the Tapioca and the target will be located either in the target's memory or in the Tapioca's memory.

## Table of Part Numbers

Part Number	Wireless protocol	Wire protocol	Prefix	Security	Casing	Power
<b>TpC-FS4W123</b>	NFC-BLE-Wi-Fi	RS-485	12	Software	DIN Rail	5V-30V
<b>TpC-PS4W123</b>	NFC-BLE-Wi-Fi	RS-485	12	Software	IP67 Compliant	5V-30V
<b>TpC-PS4M123</b>	NFC-BLE-Wi-Fi and LTE-M / NB-IOT	RS-485	12	Software	IP67 Compliant	5V-30V
<b>TpC-PS4L123</b>	NFC-BLE-Wi-Fi and LoRa	RS-485	12	Software	IP67 Compliant	5V-30V

## About IoTize

IoTize is a French company based in Grenoble area:

960 chemin de la Croix Verte  
38330 Montbonnot-Saint-Martin, France

More information at: <https://www.iotize.com/visit-iotize.html>

## 2 Summary

The Tapioca is an adapter that replaces a traditional wire connection with a secure wireless link to mobile devices (iOS or Android) or to the cloud.

---

### Radio channels

- Near Field Communication (NFC) Type5 tag (ISO/IEC 15693)
- Bluetooth Low Energy (BLE 4.2)
- Wi-Fi (IEEE 802.11 b/g/n)
- LoRa (LoRaWAN 1.0.3) (*optional with board*)
- LTE-M/NB-IoT (*optional extension board*)

### Wired communication channels

- The following ports are supported on this Tapioca Variant:
  - RS-485 with Modbus RTU.
- For asynchronous serial communication (RS-485), either a transparent mode or Modbus RTU (Master and Slave) is supported.

### Security features

- User management
- Configurable access profiles
- Configurable, encrypted passwords
- AES-128/256 module-level data encryption
- Configurable secure pairing with NFC

### Casing versions

This Tapioca variant is available only in one version:

- Fixed Standard DIN Rail case.
- Fixed IP67 Plastic case.

### Electrical characteristics

- Input voltage: 5V to 30V
- Power consumption: from 11mA to 58mA at 12VDC
- Standby mode: 0.460 mA at 12VDC

### Temperature ranges

- Operating temperature: [-25°C, +50°C]
- Storage temperature: [-25°C, +70°C]

### Acceptance

- RF certification: (*In testing*) CE (Europe), FCC (USA), IC (Canada).
- Green certification: REACH and RoHS compliant

### 3 Block diagram

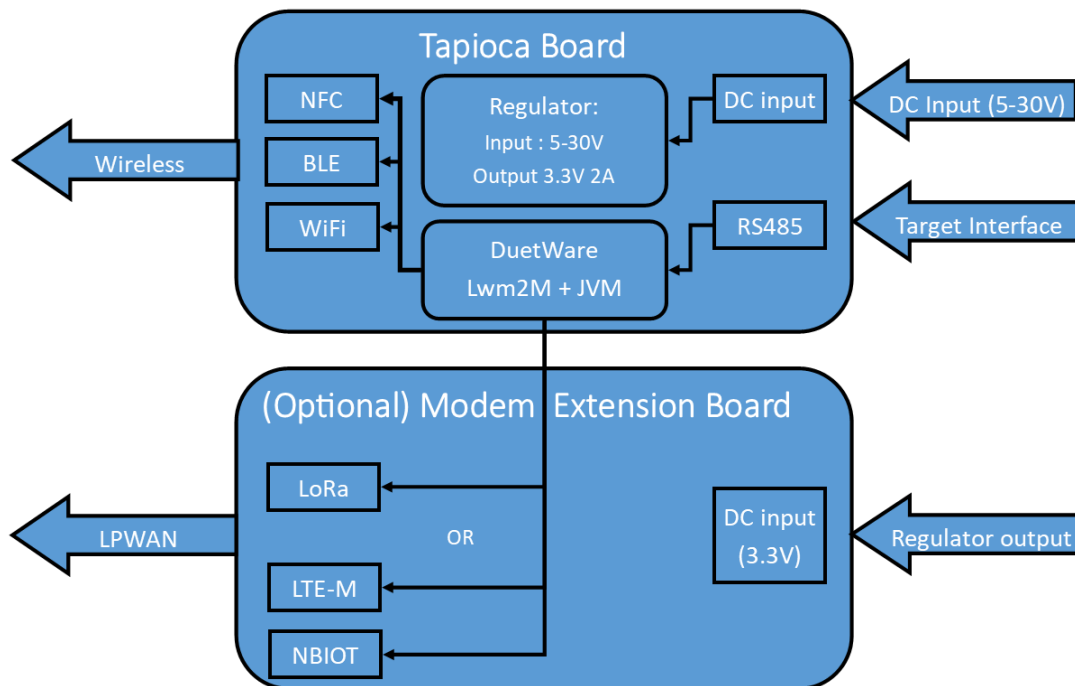

The Tapioca is made up of a standard TapNLink module connected to a RS485 transceiver. The firmware of the Tapioca gateways is the standard Duetware for TapNLink, TapNPass and Tapioca.

Two extension boards are available to add long-range, low-power wireless to any Tapioca (only available for Fixed IP67 Casing). The extension board is powered by 3.3V power supply from the Tapioca and is controlled by AT Commands. It is not possible to have LoRa and LTE-M/NBIOT in the same Tapioca, as they require different extension boards.

The communication mode is selected by configuring the module that is embedded in Tapioca.

#### 3.1 Serial modes with RS485

Two modes are available for serial communication:

- Transparent mode:** In this mode, Tapioca is used as a simple data transmission link (like a hardware cable). The protocol must be supported by the target application. The API provides basic functions such as “SendByte” and “GetByte”.
- Modbus RTU with access to variables:** In this mode, Tapioca can be either a Modbus server (slave) or Modbus client (master). In other words, variables can be considered either as being on the Tapioca (InTap variables) or on the target system. The API provides high level functions such as “ReadVariable” or “WriteVariable”. A standard CSV file can be used to import the list of the available Modbus RTU registers.

## 4 Features

Tapioca offers no code integration of wireless radio interfaces that connect a target system to a local information appliance (smartphones, PDAs, tablets, PCs, etc.) or to a network gateway (WAN, LPWAN) and the cloud.

Tapioca can communicate directly with mobiles, tablets, and PCs via NFC, BLE or Wi-Fi. Users can use IoTize's app or their own custom apps to read/write target system data. In this case, the local information appliance can also serve as a network gateway to exchange data with the cloud using the MQTT protocol.

The Tapioca Wi-Fi or LPWAN channels (with optional LoRa, LTE-M/NB-IoT extensions) can be configured to send data via MQTT to a cloud platform. The LPWAN extensions and the internal Virtual Machine allow the Tapioca to send alarms to the cloud at any time.

IoTize Tap Toolbox (Android or iOS) offers a generic interface app for communicating with the Tapioca-equipped target system. It eliminates the need to code apps in order to communicate with their target system and test connection parameters.

IoTize Tap Manager (Android or iOS) offers a generic interface for basic configuration of the Tapioca and creation of a customized human machine interface directly on the user's mobile. It eliminates the need to use a PC and server-based tools in order to create a customized user interface app.

IoTize Studio and Automatic App Generator, allow advanced configuration of Tapioca and creation of fully personalized, autonomous mobile apps.

### 4.1 Radio communication channels

#### 4.1.1 Near Field Communication (NFC)

- Data transmission rate<sup>1</sup>: 2 kilobytes per second
- Range<sup>2</sup>: up to 4 centimeters
- Supports use of NFC for dynamic wakeup and pairing of the BLE interface.

#### 4.1.2 Bluetooth Low Energy (BLE)

- Max power: +9 dBm (conducted power)
- Data transmission rate: *In testing, to be completed.*
- Range<sup>2</sup>: up to 30 meters

#### 4.1.3 Wi-Fi (IEEE 802.11b/g/n)

- Max power: +20 dBm (conducted power)
- Data transmission rate: *In testing, to be completed.*
- Range<sup>2</sup>: up to 90 meters

#### 4.1.4 LoRa

- Max power: +22 dBm at 868/915MHz
- Data transmission rate<sup>3</sup>: up to 21.9 kbits/s (SF7, bandwidth 500)
- Range<sup>2</sup>: up to 10 kilometers

#### 4.1.5 LTE-M/NB-IoT

- Max power: +23 dBm in each band
- Data transmission rate: *In testing, to be completed.*
- Range<sup>2</sup>: *In testing, to be completed.*

#### **Notes:**

1. Average speed while acquiring 1000 times 220 bytes from the target.
2. Measure line-of-site in an environment free of obstructions and rebound effects.
3. Data transmission rate from module specification.

## 4.2 Wired communication channel

For Tapioca **TpC-xS4x123** the following wired communication channel is available.

### 4.2.1 RS485

- Baud rate: up to 250 kbps
- Input Hysteresis: 100mV
- ESD protection:
  - Human-Body Model: +/-15kV
  - Air-gap discharge (IEC 61000-4-2): +/-15kV
  - Contact discharge (IEC 61000-4-2): +/-8kV

### 4.2.2 Communication cables

The communication cable is not included.

**Important Note:** *It is requested to only use shielded cable to connect the Tapioca to the target device.*

#### 4.2.2.1 Fixed Standard DIN Rail

Following are the main characteristics for the cable:

Type: RJ45 Cable

RS485: Straight-Through RJ45 Cable (T-568A)

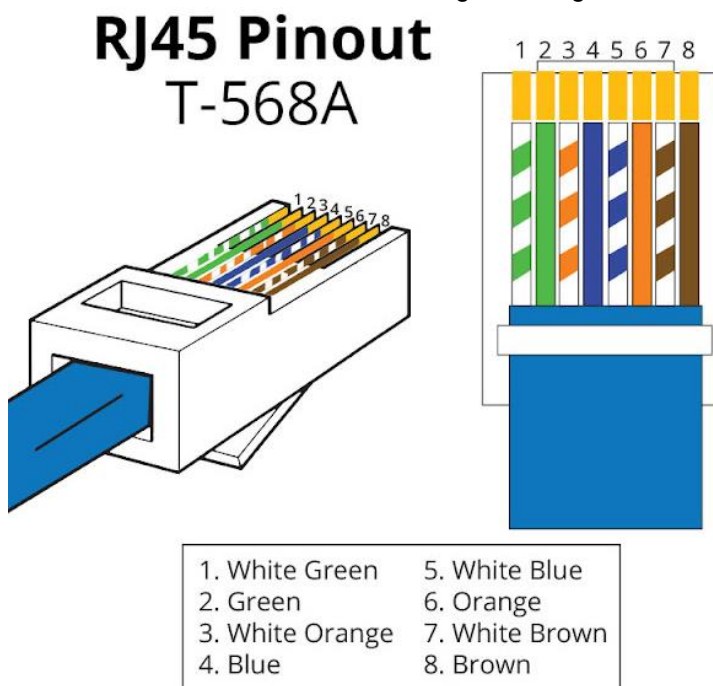

Pin RJ45	RS485 signal
1	NC
2	NC
3	NC
4	A/RS485+
5	B/RS485-
6	FCT
7	V+
8	GND

**Note:** *In standard configuration, the FCT pin is connected to a 4-20mA current loop.*



#### 4.2.2.2 Fixed IP67 Casing

Following are the main characteristics for the cable:

Type: M12 Cable (IP67)  
 RS485: M12 A-Coded Male Cable 5 Contacts

M12 A-Coded Male Connector 5 Pin Pinout

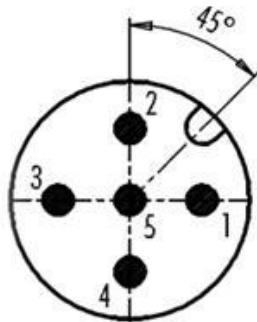

	X	Y
1	2,50	0,00
2	0,00	2,50
3	-2,50	0,00
4	0,00	-2,50
5	0,00	0,00

Pin M12 A-Coded	RS485 signal
1	FCT
2	V+
3	GND
4	A/RS485+
5	B/RS485-

**Note:** In standard configuration, the FCT pin is connected to a 4-20mA current loop.

### 4.3 Electrical characteristics

#### 4.3.1 Power supply

- Maximum DC supply voltage: 30V
- Minimum DC supply voltage: 5V
- Standard DC supply voltage: 5V, 12V or 24V
- Tapioca DC internal voltage: 3.3V

**Important Note:** For safety reasons, the Tapioca must be powered by a circuit breaker.

#### 4.3.2 Power consumption

The power consumption depends on the CPU Frequency, three different frequencies can be set: Normal, Fast and Slow. The default is the normal frequency, if needed the frequency can be lowered to minimize the power consumption of the Tapioca. Please note that the CPU Frequency must be carefully changed because it will affect the performance of the CPU.

Please note that the power consumption values below are average values and that brief power consumption peaks of several mA are expected during radio communications.

#### 4.3.2.1 Power consumption with no Extension Board

Bellow the power consumption for the Tapioca **TpC-xS4W123** at normal CPU Frequency with a stable power source of 12VDC:

Normal CPU Frequency				
Operating Mode	NFC Only <sup>1</sup>	Wi-Fi Off <sup>2</sup>	Wi-Fi Hotspot <sup>3</sup>	Wi-Fi Station <sup>3</sup>
<b>RS485</b>				
Standby	0.460 mA	0.460 mA	0.460 mA	0.460 mA
Idle <sup>4</sup>	16.6 mA	18.5 mA	46 mA	20 ~ 22 mA
NFC Tx/Rx	15.8 mA	18 mA	45 mA	20 mA
BLE Tx/Rx	-	20.5 ~ 26 mA	45 ~ 48 mA	22 ~ 27 mA
Wi-Fi Tx/Rx	-	-	48 ~ 49 mA	30 ~ 31.3 mA

Bellow the power consumption for the Tapioca **TpC-xS4W123** at fast CPU Frequency with a stable power source of 12VDC:

Fast CPU Frequency				
Operating Mode	NFC Only <sup>1</sup>	Wi-Fi Off <sup>2</sup>	Wi-Fi Hotspot <sup>3</sup>	Wi-Fi Station <sup>3</sup>
<b>RS485</b>				
Standby	0.460 mA	0.460 mA	0.460 mA	0.460 mA
Idle <sup>4</sup>	23.5 mA	25.5 mA	54 ~ 55 mA	27 ~ 28 mA
NFC Tx/Rx	22.2 mA	25 mA	54.3 mA	27 mA
BLE Tx/Rx	-	26 ~ 32 mA	53.5 ~ 57 mA	30 ~ 38 mA
Wi-Fi Tx/Rx	-	-	54 ~ 58 mA	34 ~ 39 mA

Bellow the power consumption for the Tapioca **TpC-xS4W123** at slow CPU Frequency with a stable power source of 12VDC:

Slow CPU Frequency				
Operating Mode	NFC Only <sup>1</sup>	Wi-Fi Off <sup>2</sup>	Wi-Fi Hotspot <sup>3</sup>	Wi-Fi Station <sup>3</sup>
<b>RS485</b>				
Standby	0.460 mA	0.460 mA	0.460 mA	0.460 mA
Idle <sup>4</sup>	11.7 mA	13 mA	42 ~ 43 mA	16 ~ 21 mA
NFC Tx/Rx	11 mA	12.6 mA	41.3 mA	15.5 mA
BLE Tx/Rx	-	16 ~ 20.5 mA	42 ~ 43 mA	19 ~ 27 mA
Wi-Fi Tx/Rx	-	-	42 ~ 47 mA	23 ~ 28 mA

#### Notes:

1. BLE and Wi-Fi disabled by configuration, only NFC available.
2. Wi-Fi disabled by conf, NFC and BLE available.
3. NFC and BLE are also activated.
4. BLE and Wi-Fi in advertising mode.

#### 4.3.2.2 Power consumption with LoRa Extension Board

*In testing, to be completed*

#### 4.3.2.3 Power consumption with LTE-M Extension Board

*In testing, to be completed*

## 4.4 Radio specifications

### 4.4.1 Bluetooth Low Energy (BLE 4.2) and Wi-Fi (IEEE 802.11 b/g/n)

For details, see ESP32 specifications.

Parameter	Min	Typ	Max	Unit
Wi-Fi Center frequency range of operating channels	2412	-	2484	MHz
Wi-Fi Rx sensitivity <sup>1</sup>	-70	-93	-98	dBm
Wi-Fi Tx power <sup>1</sup>	+10	-	+20	dBm
BLE RX Sensitivity @30.8% PER	-94	-93	-92	dBm
BLE Tx power	-12	0	+9	dBm

#### Notes:

1. Typical value, it depends on the type of modulation.

### 4.4.2 LoRa (LoRaWAN 1.0.3)

For details, see LoRa-E5-HF specifications.

Parameter	Min	Typ	Max	Unit
Frequency range	868	-	915	MHz
LoRa Rx sensitivity at 868MHz	-	-135	-137	dBm
LoRa Tx max power at 868MHz @SF12, BW125kHz	-	+22	-	dBm

### 4.4.3 LTE-M/NB-IoT

For details, see Monarch 2 GM02S specifications.

Parameter	Min	Typ	Max	Unit
Frequency bands	B1, B2, B3, B4, B5, B8, B12, B13, B14, B17, B18, B19, B20, B25, B26, B28, B66, B71, B85			
LTE-M/NB-IoT Low Bands <sup>1</sup> Rx sensitivity	-	-105	-	dBm
LTE-M/NB-IoT High Bands <sup>2</sup> Rx sensitivity	-	-106	-	dBm
LTE-M/NB-IoT max power for each band	+22	+23	+24	dBm

#### Notes:

1. Low Bands: B5, B8, B12, B13, B14, B17, B18, B19, B20, B26, B28, B71, B85.
2. High Bands: B1, B2, B3, B4, B25, B66.

## 4.5 Security features

The communication chain is fully secured using classic techniques based on SCRAM (Salted Challenge Response Authentication Mechanism):

- Authentication: secured passwords or signed tokens
- Encryption: AES-128/256

## 4.6 Embedded user's memory

Configuration including access control data is stored into a 16KB of FLASH. Java program and volatile data used for Java must be smaller than 64KB.

## 4.7 Low power modes

Such as all IoTize products, the Tapioca can be switched to low power mode. For now, only standby mode is available.

When in standby mode, wake-up of the Tapioca is possible by NFC or by a configurable periodic timer.

## 4.8 Temperature ranges

### 4.8.1 Operating temperature

The behavior and the radio characteristics have been tested to guarantee a correct operation in the range: **[-25°C, +50°C]**.

All the components used for this device are industrial grade components ([-40°C, +85°C] or better), moreover the main microcontroller has an operating temperature range of [-40°C, +105°C]. Theoretically the Tapioca can operate for temperatures higher than +50°C but we do not guarantee it for some reasons:

- The operating temperature is the temperature of the component, not the external environment.
- The fixed IP67 housing is hermetically sealed, and the housing temperature can be much higher than the environmental temperature.

Some connectors used in the Fixed IP67 Case are designed to operate in [-25°C, +85°C] temperature range.

It is advisable to use the Tapioca in a ventilated area and to not expose it to direct sunlight to minimize the heat in the case.

### 4.8.2 Storage temperature

The storage temperature range for the Tapioca is: **[-25°C, +70°C]**.

We do not guarantee a storage temperature higher than +70°C because of the sticker on the product.

## 5 Software environment

All IoTize hardware products are supported by a complete software ecosystem and web applications that simplify and speed their configuration, integration with cloud platforms, and/or creation of mobile apps.

Included in this ecosystem are:

- **Duetware** configurable device firmware pre-implementing all communication, security and data handling features
- **Tap Toolbox** mobile app provides utilities for setting communication parameters, testing the connection with target systems and reading/writing data to fieldbus registers.
- **Tap Manager** mobile app for device management, basic configuration, and user interface creation
- **IoTize Studio** PC software environment for advanced feature configuration
- **Automatic App Generator** for creation of mobile app projects and user interface apps for Android and iOS mobiles.

### 5.1 Device configuration

Tapioca embeds Duetware on the radio module. This can be initially configured using the Tap Manager app or using IoTize Studio PC software to configure and personalize advanced features.

Tap Manager allows device feature configuration and creation of a user interface app directly from a mobile phone.

IoTize Studio provides a complete interface for customizing the device configuration, writing code for the embedded Virtual Machine (edge data processing, cloud integration) and generating user interface apps with the Automatic App Generator. IoTize Studio provides:

- Drag-and-drop configuration of target data addresses from the target's register file
- Instant configuration transfer without extensive hardware installations
- Immediate configuration verification on the designer's PC and smartphone
- Mobile app and project generation for iOS and Android

### 5.2 Mobile device support

Tapioca includes radio implementations for NFC, Wi-Fi and BLE, which are compatible with a wide range of mobile devices running Android or iOS operating systems.

Mobile apps running on either iOS or Android can be automatically generated. Each variable can be associated with advanced graphical displays or controls (gauges, charts, bars, pies, ...) and various APIs make it possible to enrich the mobile app with external components. The project source files can also be downloaded in order to modify the app at the source level. Traditional (and easy to modify) technology based on HTML, CSS and JS are used for the graphical interface displays and controls.

### 5.3 Cloud support

Tapioca includes an open source MQTT interface. Full information about IoTize cloud support for Tapioca is provided in the IoTize Documentation center.

## 6 Hardware Description

### 6.1 Overview

The Tapioca **TpC-xS4x123** is available in both Standard DIN Rail and Fixed IP67 Casing. Below is a picture of the Tapioca RS485 electronic board:

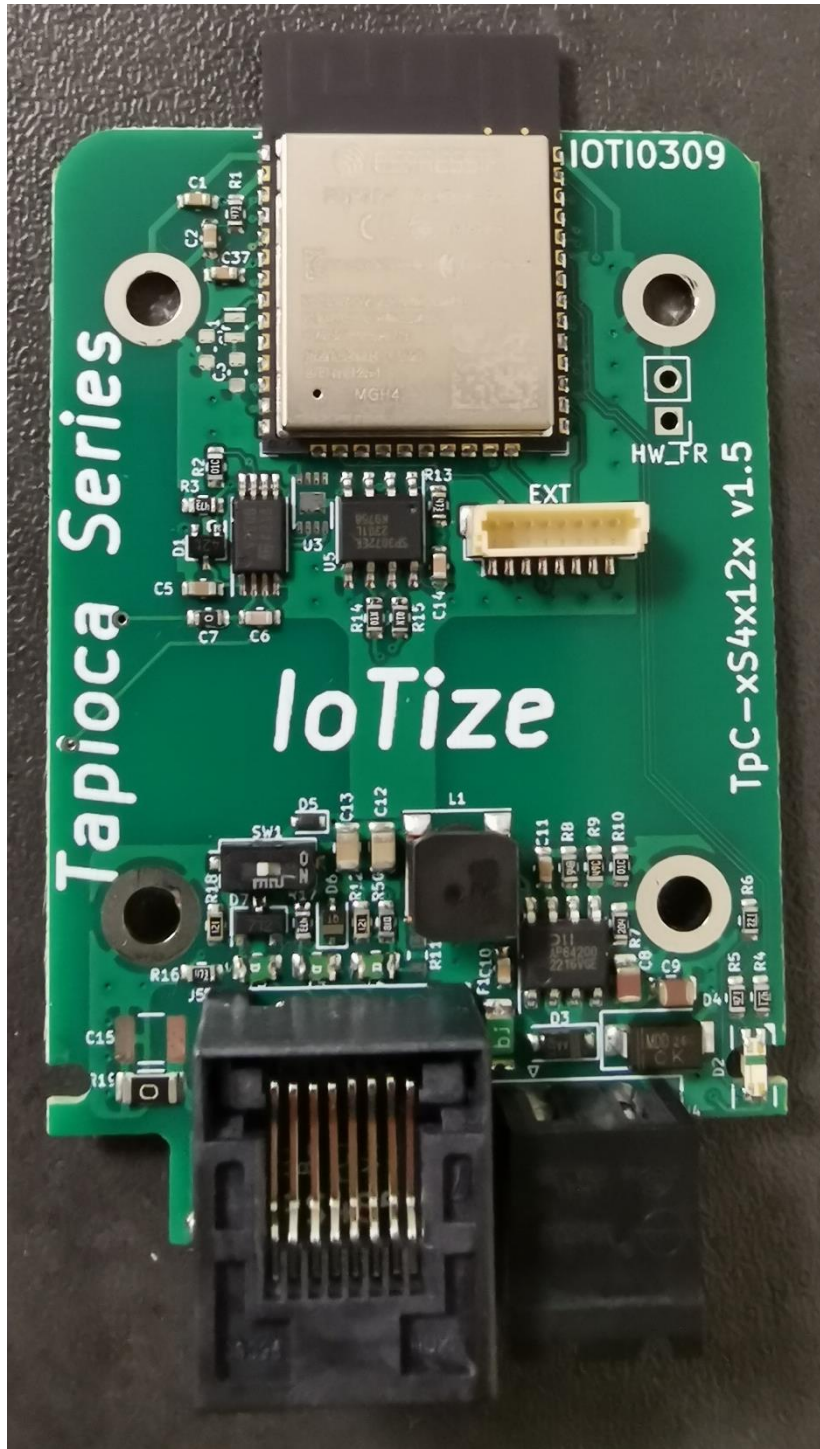

### 6.1.1 Standard DIN Rail Case

Below is an overview of this casing:

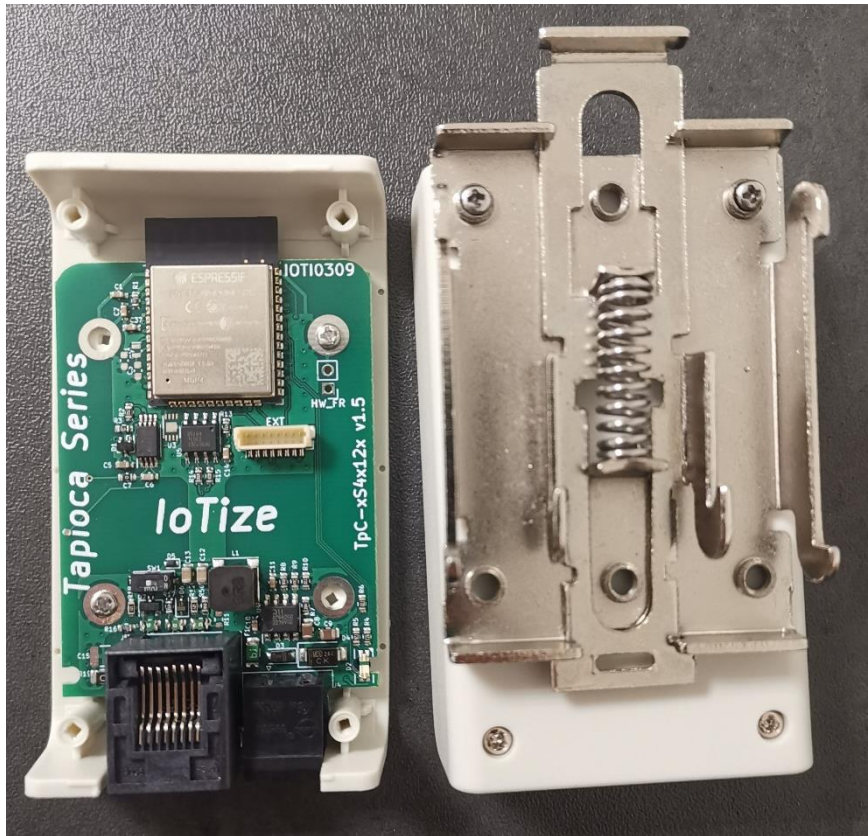

### 6.1.2 Fixed IP67 Case

Below is an overview of this casing:



## 6.2 Connectors

### 6.2.1 Standard DIN Rail Case

Type:	RJ45 and Terminal Block
RS485:	RJ45 Shielded Connector
Power:	Two pins pluggable terminal block

## Female

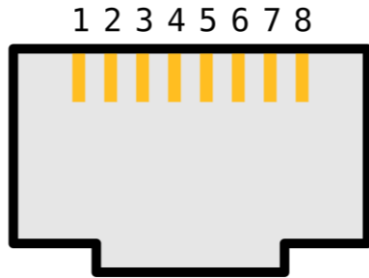

Pin RJ45	RS485 signal
1	NC
2	NC
3	NC
4	A/RS485+
5	B/RS485-
6	FCT
7	V+
8	GND

**Note:** In standard configuration, the FCT pin is connected to a 4-20mA current loop.

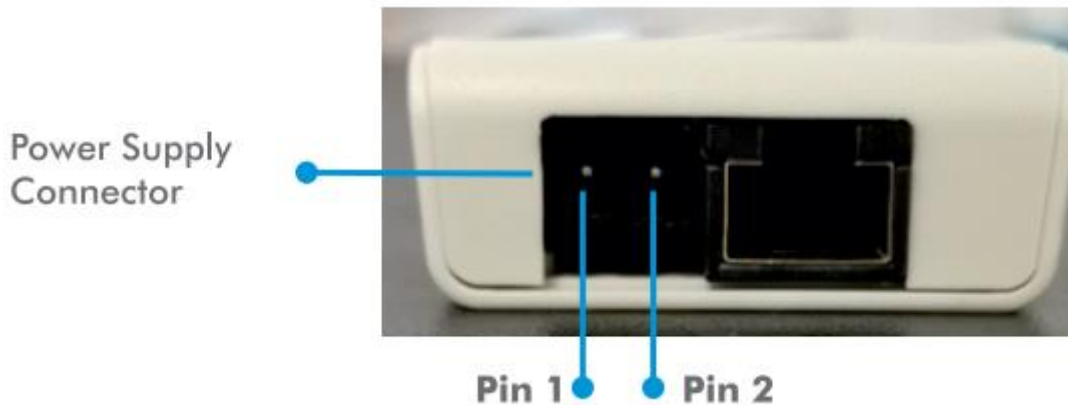

Pin Term Block	Power signal
1	GND
2	V+

**Note:** The terminal block is optional, the Tapioca can be powered from the RJ45 cable.



## 6.2.2 Fixed IP67 Case

Two connector types are available for the Fixed IP67 Case, M12 or Gland connectors.

**Note:** M12 is the default connector type for Fixed IP67 Case.

### 6.2.2.1 M12 connector

Type:	M12 Connector (IP67)
RS485:	M12 A-Coded Female Connector 5 Contacts

The pinout of the M12 connector is available in the appendix.

Below is the placement of the M12 connector:



### 6.2.2.2 Gland connector

Type:	Gland Connector (IP67)
RS485:	PG9 Gland Connector

Gland connector is a low-cost alternative to the M12 connector.

### 6.3 Hardware factory reset

A Hardware Factory Reset jumper is available on Tapioca, by default this jumper is not soldered and must be added if needed. The jumper is marked “HW\_FR” on both sides of the PCB.

The instructions for resetting to factory settings are available on the technical documentation.

**Note:** The hardware factory reset can be disabled by configuration.

Below are zoomed-in photos of the “HW\_FR” jumper on both sides of the Tapioca **TpC-xS4x123** board:

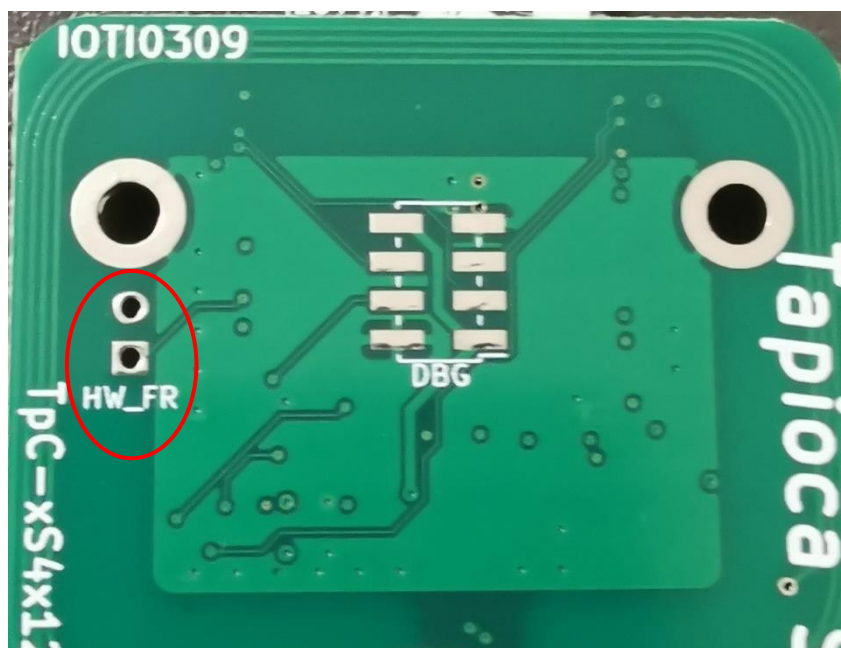

## 6.4 RS485 termination

As required by the EIA-485 standard the end devices of a RS485 bus must have a 120ohm resistor between differential signals. To respect this standard, every Tapioca device includes a 120ohm resistor and a hardware switch to connect it between the two signals.

The switch is not directly accessible from the top of the product, the two boards must be disassembled.

**Important Note:** In a polluted environment such a factory it is recommended to enable the RS485 termination resistor. By default, the switch is off.

Below is a zoomed-in view of the Tapioca **TpC-xS4x123** board with the 120ohm resistor switch circled:

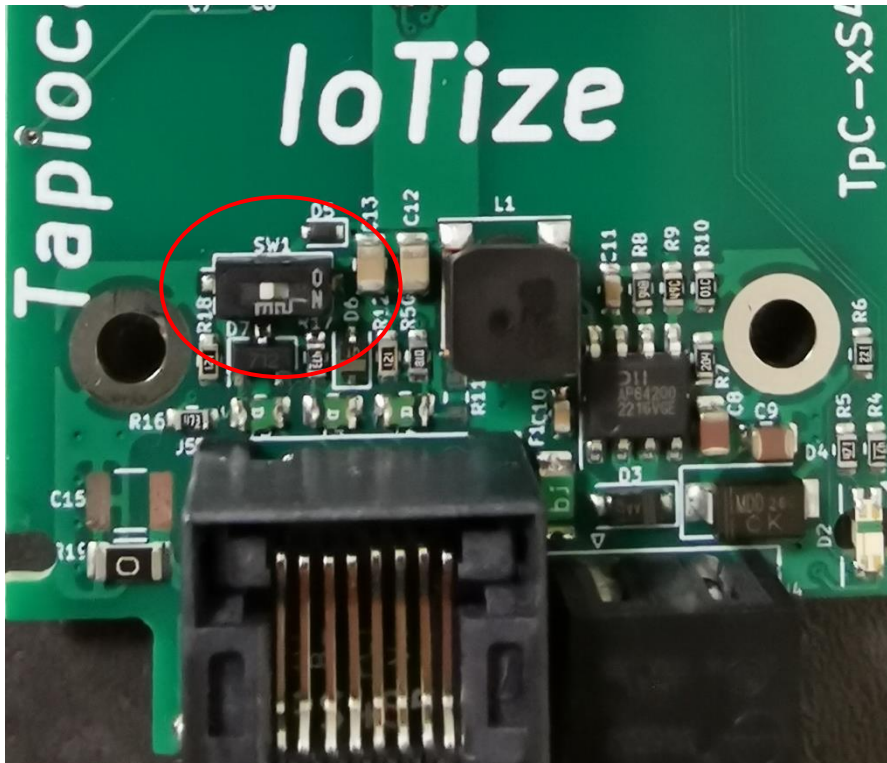

## 6.5 Configurable RGB LED

A RGB LED is available on Tapioca. This LED is not controlled by the firmware but fully configurable from the embedded Java Virtual Machine.

Some examples are available in IoTize Studio installation files. Moreover, when setting up a new project a template (adapted to the selected Tapioca) is used to generate the Java code of the project. This template contains all peripherals or pins configuration and the basic functions to control the LED on the desired Tapioca.

**Note:** On early versions of Tapioca boards, the led is bicolor (red and green). Please read the readme file in IoTize Studio example directories to select the right java file.

Below is a picture highlighting the location of the led on the Tapioca **TpC-FS4W123**:



## 7 Mechanical characteristics

The Tapioca TpC-xS4x123 is available in both Fixed Standard DIN Rail and IP67 Casing.

### 7.1 Standard DIN Rail Case

Dimensions (plastic case only):

L = 80 mm x W = 50 mm x H = 19 mm

Height with DIN Rail:

H = 33 mm

Weight (plastic case only):

40g (+/- 2g)

Weight with DIN Rail:

95g (+/- 2g)

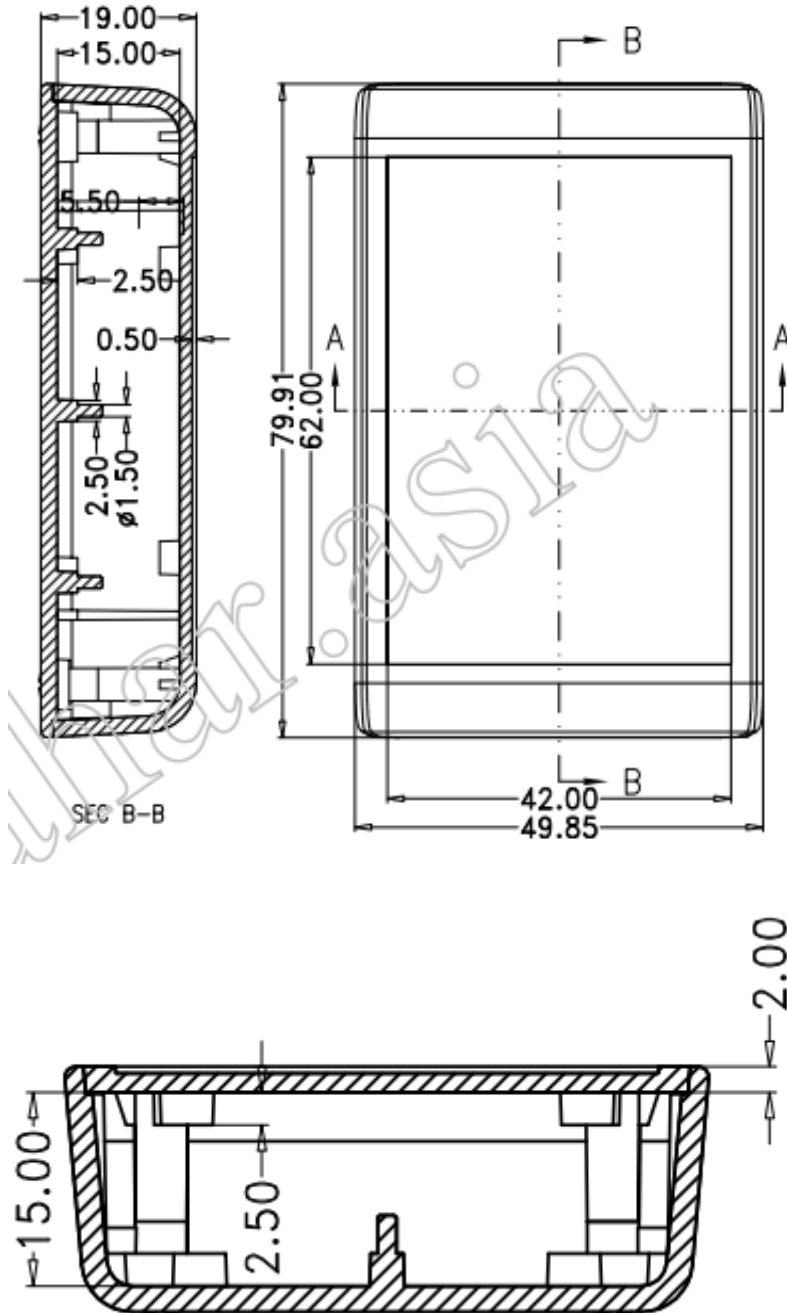

## 7.2 Fixed IP67 Case

This case is IP67 certified.

Dimensions (body):	L = 115 mm x W = 65 mm x H = 55 mm
Total length:	145 mm
Weight (without cables):	240g (+/- 5g)

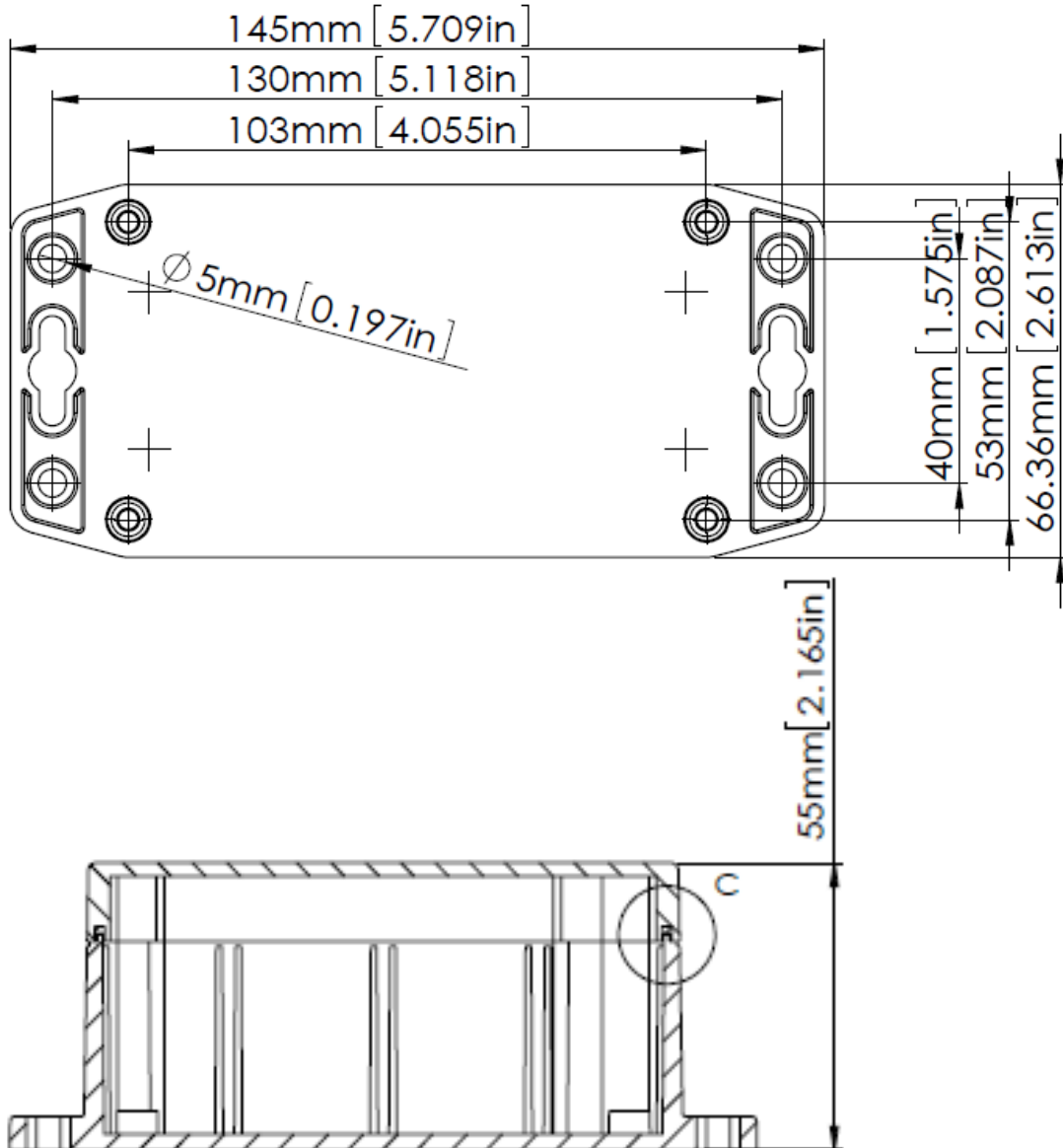

## 8 Regulatory compliance

### 8.1 CE certification (Europe)

The communication module used in Tapioca is tested for the following standards:

- EN 300 328 (V2.2.2)
- EN 301 489-1 (V2.2.3)
- EN 62368-1 (2014+A11/2017)
- EN 62311 (2008)

Tapioca has been tested for the following standards:

- EN 62368-1 (2014+A11/2017)
- EN 62311 (2020)
- EN 55035 (2017+A11/2020) / EN 61000-6-2 (2005 & 2019)
- EN 55032 (2015+A11/2020)
- ETSI 301 489-1 (V2.2.3)
- ETSI 301 489-17 (V3.2.4)

### 8.2 RoHS and WEEE

Tapioca complies with:

- Directive 2011/65/EU of the European Parliament and of the Council of 8 June 2011 on the restriction of the use of certain hazardous substances (ROHS) in electrical and electronic equipment.
- Directive 2012/19/EU of the European Parliament and of the Council of 4 July 2012 on waste electrical and electronic equipment (WEEE).

### 8.3 FCC (USA)

This product contains a transmitter module **FCCID: 2AC7Z-ESP32WROOM32E**.

To comply with FCC RF exposure compliance requirements, the antenna used for this transmitter must not be collocated or operating in conjunction with any other antenna or transmitter.

*LoRa and LTE-M variants are in testing, to be completed.*

### 8.4 IC (CANADA)

This product contains a transmitter module **IC: 21098-ESPWROOM32E**.

Ce produit contient un module transmetteur **IC: 21098-ESPWROOM32E**.

*LoRa and LTE-M variants are in testing, to be completed.*

## 9 Ordering information

Example part number: **TpC-FS4W123**<sup>1</sup>

Product Line	Use Mode	Physical Interface	Radio Interface <sup>1</sup>	Product Prefix	Security
<b>TpC</b>	<b>F</b>	<b>S4</b>	<b>W</b>	<b>12</b>	<b>3</b>

**Product Lines:**      **TpC = Tapioca**

**Use Mode:**            P    = Fixed IP67 casing  
                               **F    = Fixed Standard DIN rail casing**  
                               N<sup>2</sup> = Nomad (not available for Tapioca)

**Physical interface:** E1 = Ethernet & RS485  
                               E0 = Ethernet  
                               **S4 = Serial RS485**  
                               S2 = Serial RS232  
                               S0 = USB 2.0  
                               C0 = CAN 2.0

**Radio interface<sup>3</sup>:**    T<sup>4</sup> = NFC Only  
                               R<sup>4</sup> = BLE  
                               **W    = Wi-Fi, BLE**  
                               L    = LoRa, Wi-Fi, BLE  
                               M    = LTE-M, NB-IoT, Wi-Fi, BLE

**Security:**              **3    = software-based security**  
                               5<sup>5</sup> = hardware-based security with embedded secure element

**Notes:**

1. The features of the part number shown in the table are indicated in bold.
2. This case is not available for Tapioca.
3. All products include NFC by default for advanced functionalities such as secure wake-up and pairing.
4. These radio interfaces are not available for Tapioca.
5. Secure element management is not implemented on Tapioca.



# 10 Appendices

## 10.1 EU Declaration of Conformity (DoC)

EU Declaration of Conformity (DoC)



---

**We, the undersigned:**      **IoTize S.A.S.**  
**960, Chemin de la Croix Verte**  
**38330 Montbonnot St Martin**  
**France**  
 Email: [contact@iotize.com](mailto:contact@iotize.com)  
 Phone: +33 4 76 41 87 99

**Designated product:**      **Tapioca Wireless Adapter RS485 to NFC, BLE, WIFI**

Model:                      **TpC-xS4x12x**  
 Frequency band 1:        **2412-2484 MHz**  
 Max Power:                **19.68 dBm (802.11g)**

**Certify and declare:**      **under our sole responsibility that the designated product is in conformity with the essential requirements and provisions of the following European Directives:**

Directive **2014/53/EU** of the European Parliament and of the Council of 16 April 2014 on the harmonisation of the laws of the Member States relating to the making available on the market of **radio equipment (RED)**.  
*The conformity of the designated product(s) with the provisions of this European Directive is given by the compliance with the following European Standard(s):*

Article 3.1a concerning the requirements relative to health and safety protection of people and animals, and the protection of property with reference to 2014/35/EU directive.	- EN 62368-1 (2014+A11/2017) - EN 62311 (2020)
Article 3.1b concerning the requirements relative to protection with respect to Electromagnetic compatibility, with reference to 2014/30/EU directive.	- EN 55035 (2017+A11/2020) / EN 61000-6-2 (2005 & 2019) - EN 55032 (2015+A11/2020) - ETSI 301 489-1 (V2.2.3) - ETSI 301 489-17 (V3.2.4)
Article 3.2 concerning the requirements relative to proper use of the radio frequency spectrum.	- EN 300 328 (V2.2.2)

Directive **2011/65/EU** of the European Parliament and of the Council of 8 June 2011 on the restriction of the use of certain hazardous substances (**ROHS**) in electrical and electronic equipment.

Directive **2012/19/EU** of the European Parliament and of the Council of 4 July 2012 on waste electrical and electronic equipment (**WEEE**).



EU-DoC-Tapioca-TpC-xE1x12x, page 1 of 2

## EU Declaration of Conformity (DoC)



<b>Important Notice:</b>	Red approval is only valid for products in delivery state, including standard hardware and software. The user is responsible for operating the radio equipment and the accessories as intended and in accordance with the provided instructions. It is the responsibility of the OEM manufacturer to demonstrate compliance with all applicable EU directives and standards. The IoTize declaration of conformity serves as a support input for the declaration of conformity for the final equipment.
--------------------------	--

**The technical construction file is available from:**

IoTize S.A.S  
960 Chemin de la croix verte  
38330 Montbonnot Saint Martin  
Phone: +33 4 76 41 87 99

*Issued on April 25<sup>th</sup>, 2023.*

**Name and position of person binding the manufacturer or his authorized representative:**

Name: Francis Lamotte  
Position: President  
Email: [francis.lamotte@iotize.com](mailto:francis.lamotte@iotize.com)

Signature:



  
960, chemin de la Croix Verte  
38330 Montbonnot-St-Martin - FR  
Tel : 0476 41 87 99  
RCS : 825 335 896 - TVA : FR56825335896  
SAS au capital de 858 020 €  
[contact@iotize.com](mailto:contact@iotize.com)



EU-DoC-Tapioca-TpC-xS4x12x.docx, page 2 of 2

## 10.2 Recycling

	<p>This symbol of the crossed out wheeled bin indicates that the product (electrical and electronic equipment) should not be placed in municipal waste. Check local regulation for disposal of electronic products.</p>
---	---

### 10.3 RS485 M12 connector pinout



M12\_Connector\_RS485\_StandardPinout.odt

## IP67 Tapioca – Standard RS485 M12 Connector Pinout

M12 A-Coded Female Connector 5 Contacts Pinout

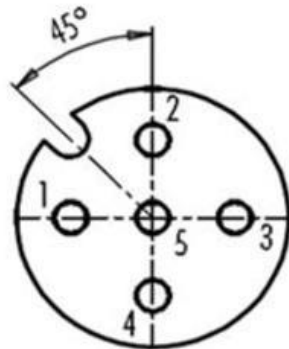

	X	Y
1	-2,50	0,00
2	0,00	2,50
3	2,50	0,00
4	0,00	-2,50
5	0,00	0,00

PIN	Wire Color	Signal
1	TBD	FCT
2	TBD	V+
3	TBD	GND
4	TBD	A/RS485+
5	TBD	B/RS485-

**Note:** The wires must not be yellow, white, orange or blue.

1

## 11 History

Date	Version	Author	Modification
Nov. 2021	0.1	FL	First draft preliminary release version.
Jan. 2022	0.2	FL, JH	Text corrections.
Jan. 2022	0.3	SG	Update part numbers.
Mar. 2022	0.4	SG	Corrections and part number updates.
Nov. 2022	1.0	ES, SG	First release version for TpC-xS4x123 Family.
Jan. 2023	1.1	ES	Update operating and storage temperatures. Update ordering information. Rename the file.
Mar.2023	1.2	ES	Update input voltage.
Nov. 2023	1.3	ES	Fix Recycling appendices. Update Regulatory compliance. Add "About IoTize" section and fix "Power" in "Table of Part Numbers" in Introduction. Add important notes to RS485 termination and Power supply sections. Add EU Declaration of Conformity (DoC). Add Gland connector section. Update Block diagram. Update Configurable RGB LED. Update RS485 ESD protection information. Update pictures of the Tapioca electronic board.



### **Disclaimer**

Information in this document is subject to change without notice and does not represent a commitment on the part of the author(s).

No part of this document may be reproduced or transmitted in any form or by any means, electronic or mechanical, including photocopying, recording, or information storage and retrieval systems, for any purpose other than the development of the IoTize™ technology, without prior written permission from IoTize SAS and the IoTize™ consortium members.

Every effort has been made to ensure the accuracy of this manual and to give appropriate credit to persons, companies and trademarks referenced herein.

This document exists in electronic form (pdf) only.

### **Copyright © IoTize All rights reserved**

*IoTize™ is a registered trademark of IoTize SAS. All other registered names and trademarks are the property of their respective owners.*